



**Nozzles and Systems
for the
Metallurgical Industry**



Steel

**Non-ferrous
metals**

Aluminium

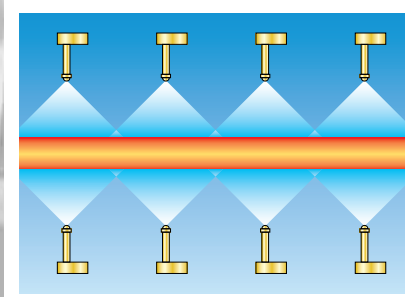
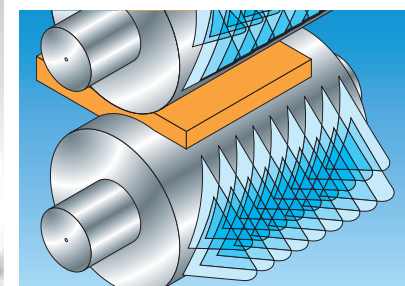
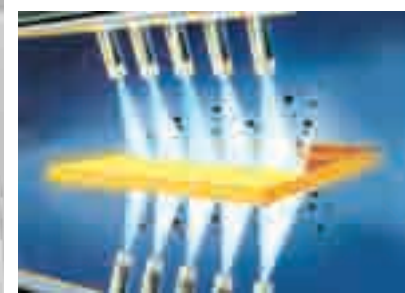

COMPETENCE IN THE METALLURGICAL

Lechler nozzles have been setting standards in quality, performance and design for over 135 years.



A wide range of specially developed and proven nozzles of many different designs and in a range of materials is available for applications throughout the processes of metal smelting, refining, casting, rolling and processing. You can also select from over 20,000 other Lechler nozzles for a very wide range of other applications – with new ones being added to the range daily!



Nozzle development



Commissioning and training by Lechler staff

INDUSTRY

A dynamic market with high expectations

Global steel production will increase dramatically in the years ahead. The globalisation of the steel industry is not yet complete.



Every year, new steel-making companies are being newly formed, with production plants on every continent. The trend is similar in the case of the aluminium industry and the producers of non-ferrous metals.

The metallurgical industry places stringent demands on its suppliers

Most metallurgical plant and machine builders are already organised and active globally. Process optimisations, along with new technologies, enable production capacities to be permanently increased and the product quality of the metals produced to be further improved.

Nozzles and nozzle systems play an important role here in all production stages. The following basic requirements must be met for a successful partnership:

Great innovative strength in order to realise new technologies.

High problem-solving competence for ensuring plant availability.

Global organisation as a guarantee of customer proximity and worldwide service.

Lechler meets these requirements in full.

Wherever you are in the world, Lechler is close by and employs over 650 people

With production facilities in Germany, the USA, England, Hungary, India and China, sales offices in France, Spain, the BENELUX countries, Sweden and Finland, and representatives in over 25 countries, Lechler has a global network of service stations. This guarantees technical support for plant operators, a supply of spare parts and ongoing training of maintenance staff throughout the world.

Everything is in Lechler's favour

Leadership in technology

We use advanced design and production technologies.

Process-related competence

combined with unsurpassed nozzle know-how allow us to find the optimum technical solutions.

A worldwide service network

A supply of spare parts and technically competent after-sales service are guaranteed.



Headquarters, Germany



Lechler Ltd., United Kingdom



Lechler Inc., USA

UNSURPASSED NOZZLE KNOW-HOW AND A WELL-FOUNDED KNOWLEDGE OF THE INDUSTRY

The plant builder's partner

With its innovative nozzle solutions, Lechler is always involved in the introduction of new technologies and also in the continuous further development of conventional processes.



A well-founded knowledge of the industry

As an active member of many different national and international associations (VDMA, VDEH, AIST, S.E.A.I. & S.I., ATS and EUnited) and via numerous technical publications, Lechler has become very familiar with the subject matter. Participation in EU research projects (RFCS) also has increasing Lechler's technological competence as its goal. Of course, you as our client also profit from this. Significant changes to operating conditions with regard to throughput capacity and the product quality demands of modern materials can arise over the course of the very long service lives of metallurgical machinery. Today the production of a wide range of material qualities also demands a much greater flexibility in the operating procedures and in maintenance. This is where existing plants often reach their limits.

Besides the construction of new plants, one alternative can be the optimisation of existing ones.

The most common reasons for this are:

- Identifying and remedying quality problems
- Improving ease of maintenance and lowering maintenance costs
- Increasing production by increasing the production speeds
- Changing the product formats and the material qualities (product mix)

In most cases, the decision involves a combination of the above reasons. It is therefore important for the aims to be clearly defined.

Lechler nozzle configuration

An optimum nozzle configuration is the main prerequisite for fulfilling the production and quality specifications of all plants.



New nozzle solutions open up many different possibilities for saving costs. The optimisation of nozzle systems can also make a significant contribution towards increasing production, quality and flexibility. With the help of Lechler's own PC-based simulation programs, we can analyse the current situation and make optimisation suggestions based on state-of-the-art nozzle technology.

Lechler system audits

Roll cooling in hot- and cold rolling mills (steel, aluminium and non-ferrous) and also secondary cooling in continuous casting machines for steel are very complex systems and form part of the complete production processes. The full optimisation potential can often be determined only via a precise study of all the important details. Lechler system audits include an evaluation of the existing production, performance and quality data, along with a carefully documented final report which, in addition to the collected and analysed data, also contains suggestions for optimising your system.

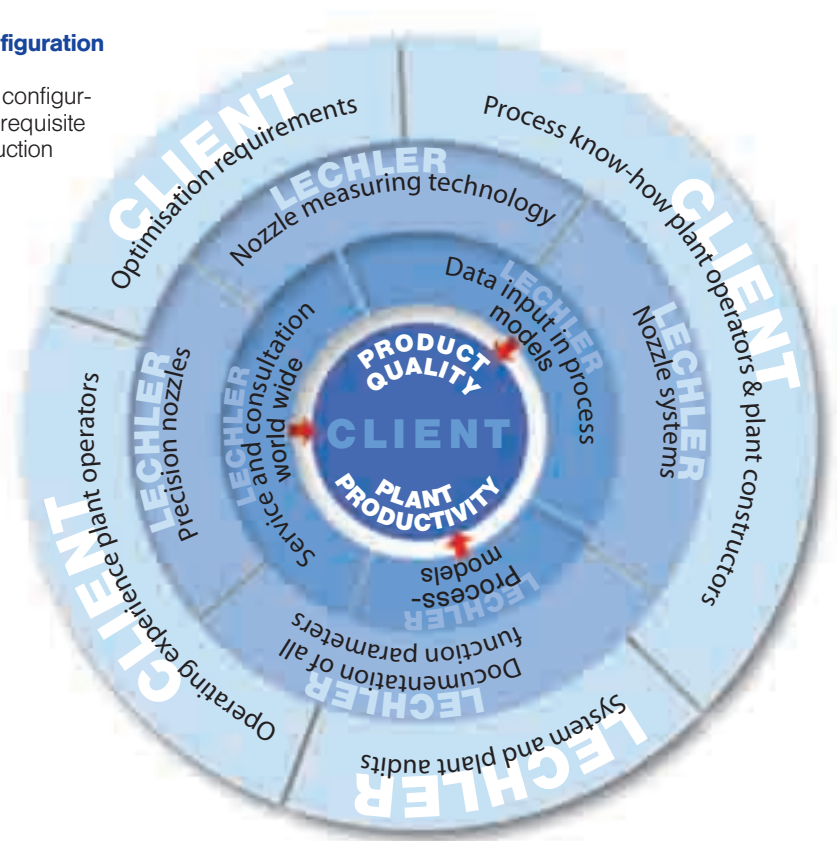

SPECIAL NOZZLES AND SYSTEMS FOR EVERY FIELD OF APPLICATION



- Precision nozzles
- Nozzles and application systems
- Nozzle configurations
- Application software
- Computer simulation
- Nozzle measuring technology
- Plant audits and process optimisation
- Maintenance and commissioning
- Training
- Spare part management
- Continuous casting of steel
- Hot and cold rolling of steel
- Hot and cold rolling of aluminium and non-ferrous metals
- Strip processing
- Other applications in metallurgical processes



STATE-OF-THE-ART TECHNOLOGY TO ELIMINATE ALL RISKS

Data and facts that you can rely on

There are many reasons for our product's success: A very important one is that based on precise measurements, we are able to make reliable statements about the spray characteristic of a nozzle.

This provides reliable data for development, and also simplifies the evaluation for you with regard to fulfilling the exact purpose in the individual application - even before the nozzle has been integrated into your system. This saves time, reduces costs and ensures planning reliability.



We employ the latest methods to cover the entire measurement spectrum

- Flow rate
- Spray angle
- Spray shape
- Air flow measurement
- Droplet size measurement
- Droplet speed measurement
- 3D spray impact measurement
- Liquid distribution
- Spray videos
- Noise level measurement

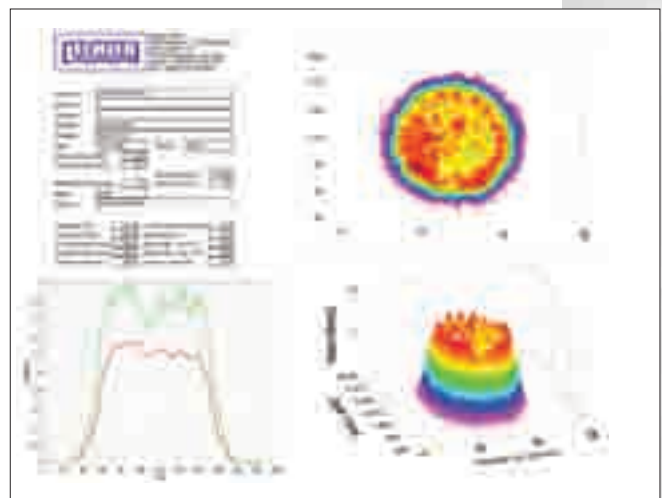

Documentation of a spray impact measurement

The performance data is determined with state-of-the-art measuring techniques and is documented accurately.

SIMULATING AND SUCCESSFULLY OPTIMISING PROCESSES

Computer technology provides you with a glimpse into your plant's future

Lechler uses in house developed application software programs in order to work out optimum solutions. This enables nozzle configurations to be simulated, analysed and depicted.

Lechler configuration programs have also been used successfully for many years during the design of new plants. Nozzle data from Lechler measuring technology forms the basis here for reliable calculations that reflect reality.



Roll cooling, strip cooling and lubrication

Lechler has developed a special computer program for optimising work roll cooling. The measured nozzle data and the installation conditions can be used to graphically depict (in the form of flow diagrams), analyse and improve the liquid distribution on the roll surface.

Strip cooling, cleaning and lubrication solutions can also be derived in this way.

Solidification model for continuous casting machines

So that we can also be a competent consultation partner with regard to questions relating to the optimisation of nozzle configurations in continuous casting machines, Lechler has developed a solidification model with which benchmarking can be carried out within the context of a plant audit. On the basis of this and in line with the aims, it is then possible to investigate optimisation potentials in detail.

Lechler DESCALE

With the introduction of the SCALEMASTER® descaling nozzles in 1992, Lechler was the first nozzle manufacturer to develop and successfully use a configuration program. Since then, most descaling plants of the largest and most renowned plant builders have been designed and constructed with Lechler DESCALE software.

Hundreds of descaling spray headers throughout the world have been optimised in this way. In all cases, with this tool Lechler has also made a crucial contribution towards increasing surface quality and plant efficiency.

Temperature profile of a continuous casting machine

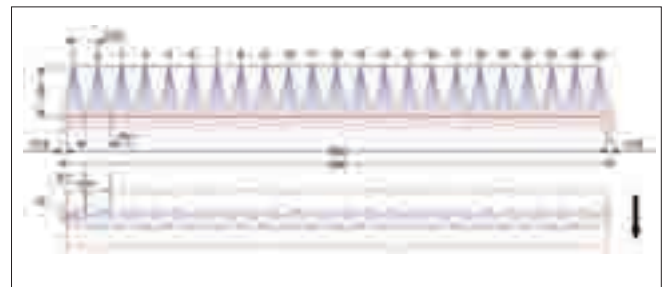
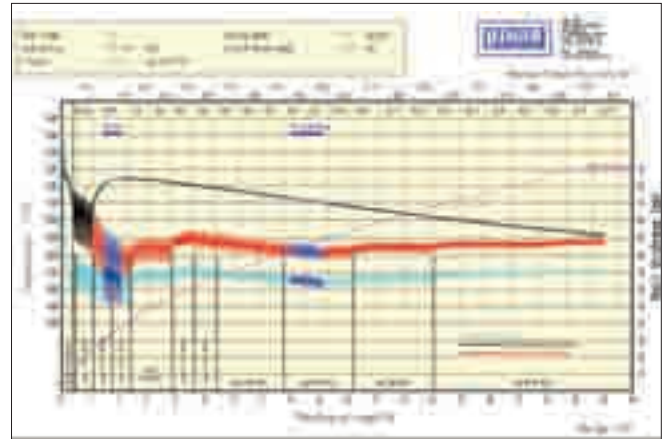

The Lechler DESCALE software optimises the nozzle arrangement on a descaling spray header

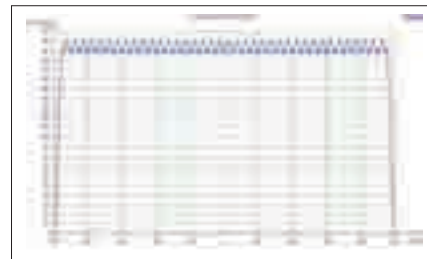

Liquid distribution for strip cooling

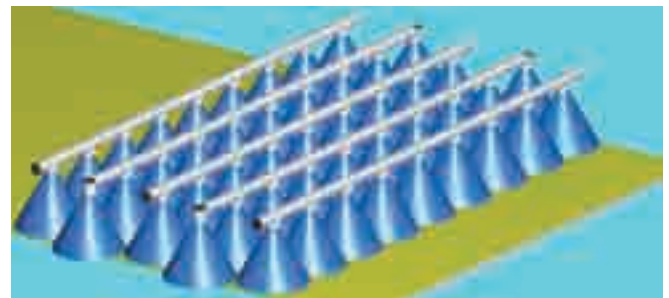

Visualisation of the nozzle arrangement for strip cooling

NOZZLES FOR OPTIMUM SECONDARY COOLING



At Lechler, you will find the right solution for every plant

It doesn't matter whether equipment for billet, bloom, slab or thin slab continuous casting machines is involved. The program ranges from standard single fluid nozzles for billet plants for more simple reinforced steels right through to special twin fluid nozzles (BilletCooler air mist nozzles) for plants in which very high-grade steels are cast for tyre cord or seamless pipes.

Modern slab continuous casting plants are in most cases fitted with specially designed and customised air mist nozzles of the Master-cooler type. This applies to both conventional thick slab plants and the more compact thin slab plants.



Preparation of a measurement of the nozzle heat transfer coefficient

Single fluid nozzles

Lechler single-fluid nozzles with a flat spray pattern or full cone nozzles are available with standardised flow rate and spray angle graduations. Rectangular nozzles produce a flat jet with a greater spray depth.

In addition to a standard program, variants of this nozzle family are designed especially for individual plants.



Liquid distribution measurement

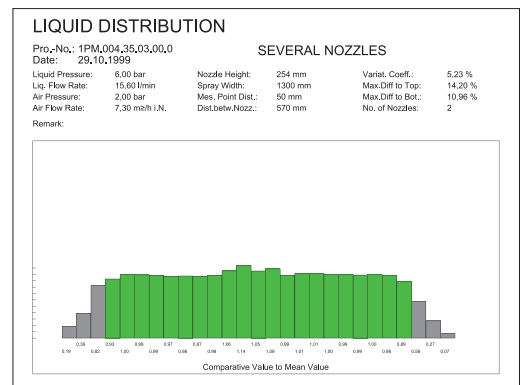

Documentation of a liquid distribution





- Single-fluid nozzles with full cone, flat jet and rectangular spray patterns
- **BilletCooler** full cone air mist nozzles
- **BilletCooler** Oval air mist nozzles
- **MasterCooler** air mist nozzles
- Nozzle measuring technology and documentation
- Nozzle configurations
- Plant and system audits
- Conversion of the pipes and nozzle fittings of complete continuous casting segments
- Complete spray headers and spray rings

Air mist nozzles

With the **BilletCooler** series, Lechler offers the world's first air mist nozzle for secondary cooling with a defined full cone. The Lechler BilletCooler Oval is the first air mist nozzle for secondary cooling with which a spray depth of up to 60° is possible with a non-clogging single slot orifice. This enables larger surface areas between the support rollers to be cooled more evenly. This in turn reduces the risk of strand cracking.

Air mist nozzles of the BilletCooler series should be used wherever the control range of single-fluid nozzles is no longer sufficient for the wide range of steel products in billet- or bloom casters, or when the nozzle's flow rate falls to well below 2 l/min. Standard programs with a full cone spray pattern and with an oval spray pattern with likewise standardised flow rate, spray angle and spray depth graduations are available. Defined spray patterns, high turn down ratios (min. to max. flow rate) and very large free cross sections (not liable to

clogging) are the stand-out features of BilletCoolers.

MasterCooler SMART® air mist nozzles are designed in line with the requirements of the secondary cooling system of each individual slab caster. The water flow rate, the spray angle, the liquid distribution, the turn down ratio, the pipe length, the pipe shape and the type of connection are all adapted here. To date, more than 100 slab strands have been successfully fitted with MasterCooler SMART® air mist nozzles.

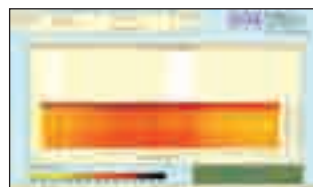

Strand temperature profile half width, total length



MasterCooler SMART® in slab plant

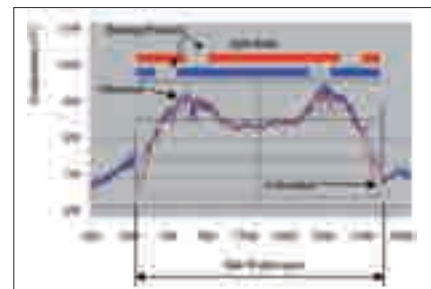

Temperature profile across strand, measured and calculated

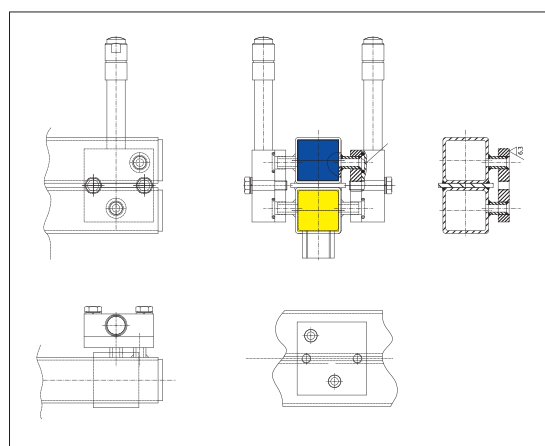

MasterCooler SMART® installation



NOZZLES FOR MORE EFFECTIVE DESCALING



This is one of our specialist areas – hardly anyone knows more about this than we do

When steel is hot-rolled, the quality of the rolled product surfaces depends very significantly on effective descaling. The selection of the best descaling nozzles and their optimum arrangement is crucial here. Also, rising energy costs and ecological considerations are increasingly forcing rolling mill operators to define energy-saving measures and to implement them in the form of concrete measures.

The new **SCALEMASTER HP Superior®** from Lechler has immediately started to set new standards in this area. When this nozzle was developed, the use of computer-based design methods (CFD) enabled us to largely eliminate internal liquid turbulences and pressure losses. This meant that a maximum impact increase could be achieved. Thanks to compatibility with earlier models, this allows even more effective descaling for the same energy input. In addition, it also opens up significant saving potentials due to reduced cooling of the rolled product by reducing the amount of water sprayed.

The use of new materials and the reduction in the number of individual components increase both service lives and operational reliability – two further economy advantages. Nozzle configurations can be determined quickly and reliably thanks to the combination of measured values and calculation models in conjunction with the Lechler DESCAL configuration software. This ensures planning reliability and is one of the reasons why globally, several hundred descaling systems have been very successfully fitted with Lechler SCALEMASTER® nozzles.

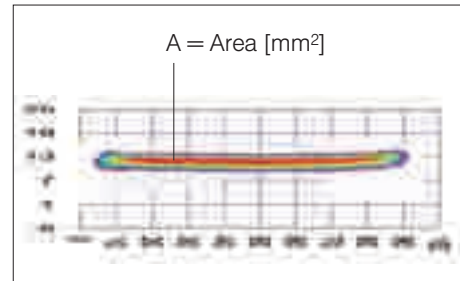

Spray footprint diagram



3D measurement protocol, impact measurement

Stabiliser filter unit with optimised flow thanks to Computational Fluid Dynamics (CFD)

SCALEMASTER **HP**
SUPERIOR

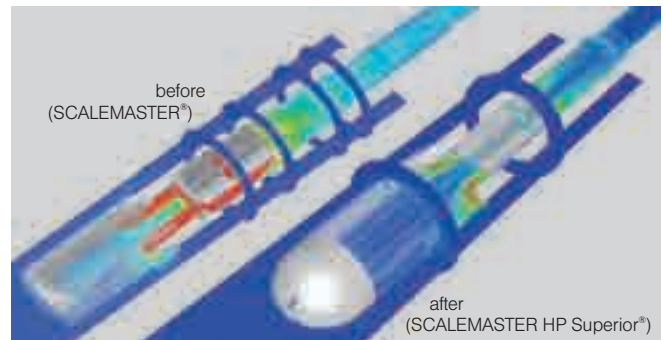

PERFECT TECHNOLOGY FOR ROLL COOLING AND MUCH MORE



Lechler nozzles combined with our process know for better roll cooling results

Only optimal nozzle arrangements guarantee highest productivity of a rolling mill. Therefore, roll cooling systems and headers shall be designed to extract heat from the rolling process in a controlled and efficient way that assures optimum control of roll temperature.

Lechler Thermal Roll Cooling Study for better roll cooling results

A roll cooling study is a systematic and structured approach and delivers a wide range of benefits by determining the potentials optimized nozzle and header arrangements offer with regard to improvements in product quality, productivity and reduced operation costs.

Optimum strip flatness thanks to simulation of the nozzle arrangement

The final study report provides solutions focussing on:

- Maximum heat extraction for minimum coolant volume applied
- Symmetrical thermal profiles on the work rolls (minimum gradient in temperature)
- Controlled thermal crowns
- "Normal" steady state roll temperatures
- No differentials in the thermal conditions between the top and bottom work roll

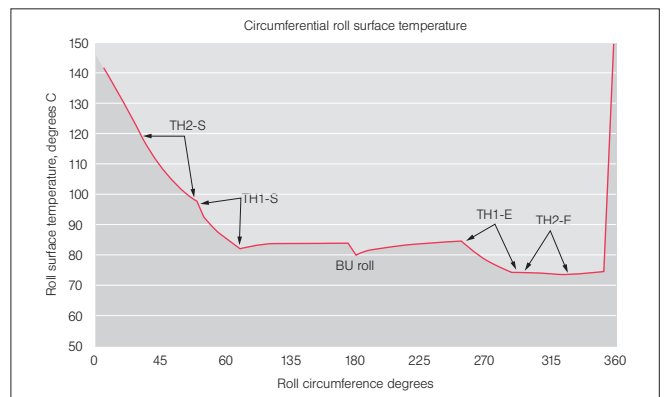

Circumferential roll surface temperature simulation indicating spray header position

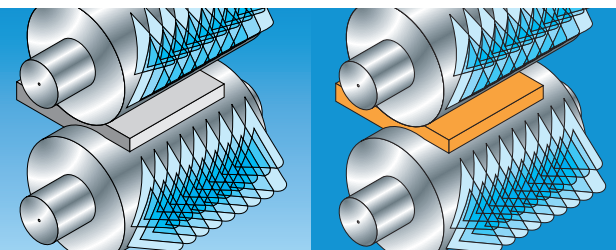

COLD ROLLING OF STEEL, HOT AND COLD ROLLING OF ALUMINIUM SELECTOSPRAY® ROLL COOLING SYSTEM



SELECTOSPRAY® – an indispensable actuator for shape control. It corrects reliably asymmetrical strip shape defects and supports work roll bending

To date, more than 300 Lechler SELECTOSPRAY® roll cooling systems have been installed globally in cold rolling mills for steel, aluminium and non-ferrous metals, as well as in aluminium hot rolling mills and foil mills. Profit from our comprehensive know-how in this specialist area.

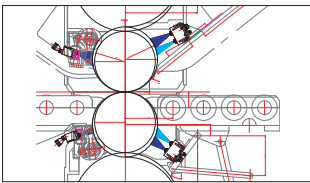

Selective roll cooling system, individually designed

The principle

To achieve precise cooling control, the roll barrel is 'divided' into zones, each of which has coolant precisely applied to it by MODULAX valve controlled spray nozzles. Each of the zonal sprays can be operated independently of the others either manually, by push button control, semi automatically by a PLC, or automatically in connection with a shape control system.

The SELECTOSPRAY® system can be used in conjunction with any of the shape control systems currently available, the roll zoning being dimensioned to exactly match that of the shape metering roll involved. Zone widths for both automated and manually controlled systems are available, widths in general use being between 25 mm and 100 mm.

The SELECTOSPRAY® system includes complete headers, air hoses and control cabinet.

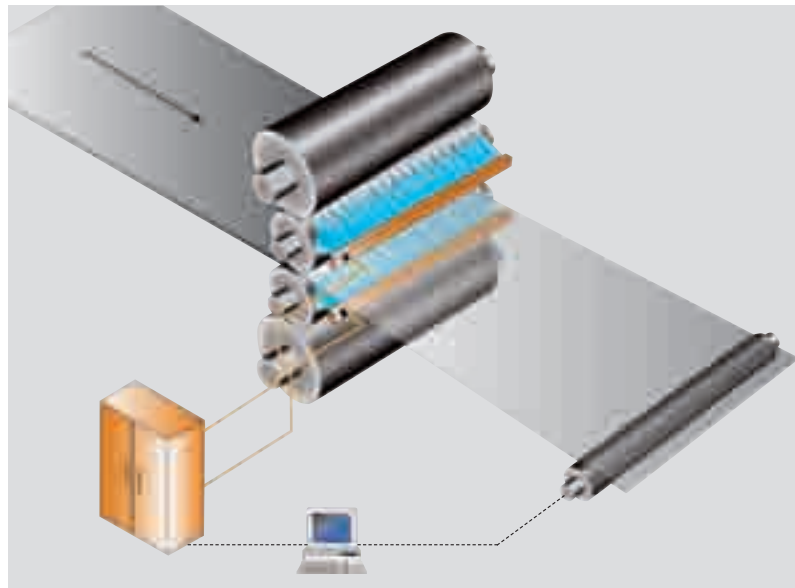

Electrically controlled SELECTOSPRAY® system with EVA valve technology (25 mm/1", 50 mm/2")



Control cabinet



Air and cable hoses

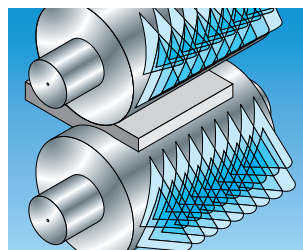

EM FOR STRIP SHAPE CONTROL

Lechler competence and expertise

Of paramount importance for any roll cooling application is how the sprays impinge on the roll surface. An effective and precise footprint geometry is the fundamental requirement to establish a uniform cooling from top to bottom work rolls and transversely across the cooling area resulting in an optimal heat extraction across the spray cooling area on the roll.

When designing a spray header Lechler arranges the sprays without interference or creating hot and cool bands in adjacent cooling zones. The nozzle flow rates and spray angles are taken into account besides the positions of the spray headers in the mill for the design of the optimal nozzle offset and impingement angles in order to obtain the best heat transfer.



Lechler SELECTOSPRAY® valves

The proven Modulax valve design is available in three different versions:

- Pneumatically controlled with the solenoid in the control cabinet outside of the mill
- Electro-pneumatically with the solenoid directly attached (DSA)
- Purely electrically controlled (EVA)

All valve versions have very large coolant entry ports, are easily removable from the header front and are protected by the header itself. All valves carry self-aligning flat jet nozzles.

Lechler SELECTOSPRAY® valves (MODULAX)



- Liquid to air pressure ratio 2:1
- Very large internal free passages
- Uses standard shop air
- Simple design, only one moving part which is the piston



Electro-pneumatic valve actuation (DSA)



- Each valve has its own dedicated solenoid directly attached
- Shorter response time.
- Air for the pilot operation is fed by a single tube directly into the header and instantly available when the electrical solenoid is activated
- Solenoids can be supplied in either normally open or normally closed

Electric valve actuation (EVA)



- Especially in rolling mills where inflammable rolling oil or kerosene is used as a coolant and without the need for compressed air
- Large orifices for a laminar flow and a stable spray

VARIETY OPENS UP NEW POSSIBILITIES



Lechler is the specialist company for nozzle and spray technology. Make use of the advantages of this wide product range

WHISPERBLAST® air nozzles made of stainless steel or plastic are used for blowing off strips or strip edges.

Special Lechler hollow-cone nozzles made of oxide cera-

mic, silicon carbide, titanium and palladium-titanium are installed for regenerating acid in pickling lines after the spray-roasting process.

Self-cleaning spray pipes (the "STAMM" system) allow nozzles and the pipe inner walls to be cleaned in a matter of seconds during operation. This is done either manually or automatically by rotating a cleaning brush inside the spray pipe. This prevents unscheduled and expensive plant shutdowns, and safeguards the product quality of the strip.

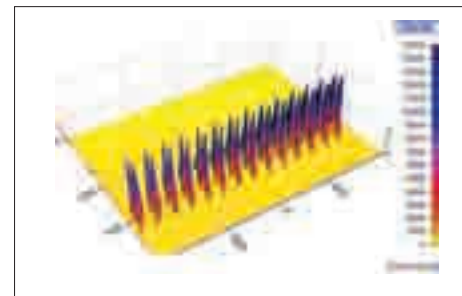

Liquid distribution of a nozzle arrangement



Self-cleaning »STAMM« spray pipe system

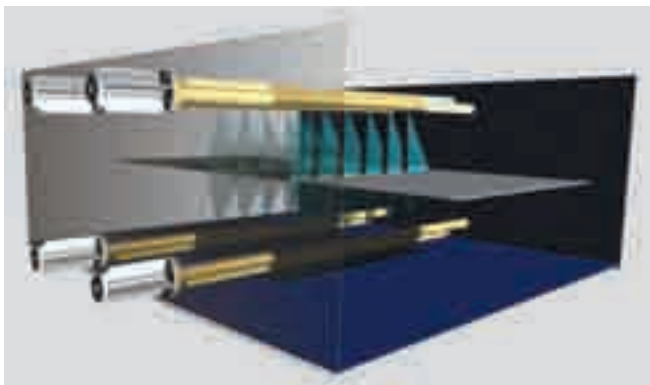

With Lechler nozzles, you can optimally fulfil all typical requirements on pickling, galvanising and tinning lines, on strip coating lines, and on continuous annealing lines. These include cleaning and rinsing processes, but also the direct application of acids, for example. A wide range of standardised flat jet, tongue and full-cone nozzles made of various materials such as PVDF, PTFE, polypropylene or stainless steel provide a broad basis for future-orientated and technically perfect solutions.

mic, silicon carbide, titanium and palladium-titanium are installed for regenerating acid in pickling lines after the spray-roasting process.



OTHER NOZZLE AND SYSTEM APPLICATIONS



Coke ovens

- Coke quenching
- Liquor flushing in the coke oven
- Cleaning the coke oven battery doors
- Gas cleaning and droplet separators

Blast furnaces and sintering plants

- Combating dust and dust deposits on conveyor belts and transfer points
- External wall cooling
- Gas cleaning - gas cooling
- Gas cleaning in the slag granulation



Hot rolling

- Settlement of oxide dusts in the stand
- Intermediate stand cooling
- Strip surface quenching to protect the work rolls
- Strip spray-off and blow-off
- Blowing off heavy plates upstream of the levelling machine
- Crop shears blade cooling in pendulum shears
- Ultra fast cooling / quenching of plates and strips
- Strip cooling in the run-out roller table
- Rolled product cooling on the cooling bed



Steel production

- Electric furnace hood cooling
- Electrode cooling
- Cooling the outer skin of the converter
- Exhaust gas cooling and conditioning
- Dust suppression

Continuous casting machines

- Flushing the scale channels
- Spraying off the slag during flame cutting
- Roller cooling
- Machine cooling
- Mould spray cooling



Forging and pipe production

- Mandrel bar and tow bar cooling and lubrication
- Descaling forged pieces
- Roll cooling in railway wheel manufacture



Other applications

- Gear lubrication
- Pickling and flushing steel wire in pickling plants





Lechler GmbH
 Precision Nozzles · Nozzle Systems
 P.O. Box 13 23
 72544 Metzingen / Germany
 Phone: +49 (0) 71 23 962-0
 Fax: +49 (0) 71 23 962-333

E-Mail: info@lechler.de
 Internet: www.lechler.de



Yes, I want to get detailed information on Lechler products

Please send me the special information:

- Catalogue »Precision Spray Nozzles and Accessories«
- Brochure »Roll Cooling«
- Brochure »Continuous Casting«
- Brochure »SELECTOSPRAY® Roll Cooling Systems«
- Brochure »SCALEMASTER HPS®«
- Brochure »SCALEMASTER® HP«
- Brochure »MicroSCALEMASTER®«
- Brochure »Water Stop Valve WSV«
- Brochure »VarioCool® Gas Conditioning Systems«
- Brochure »Measurement Technologies«

Special interests:

Our Address:

Name _____

Company/Department _____

P.O. Box/Street _____

Postcode/City _____

Country _____

Phone _____

E-mail _____

Belgium: Lechler S.A./N.V. · Avenue Mercatorlaan, 6 · 1300 Wavre · Phone: +32 10 225022 · Fax: +32 10 243901 · info@lechler.be
China: Lechler Intl. Trad. Co. Ltd. · Beijing · Rm. 418 Landmark Tower · No. 8 Dong San Huan Bei Lu · Phone: +86 10 84537968, Fax: +86 10 84537458 · info@lechler.com.cn
Finland: Lechler Oy · Jäspiilänkatu 18 · 04360 Kerava · Phone: +358 207 856880 · Fax: +358 207 856881 · info@lechler.fi
France: Lechler France, S.A. · Bât. CAP2 · 66-72, Rue Marceau · 93558 Montreuil cedex · Phone: +33 1 49882600 · Fax: +33 1 49882609 · info@lechler.fr
Great Britain: Lechler Ltd. · 1 Fell Street, Newhall · Sheffield, S9 2TP · Phone: +44 114 2492020 · Fax: +44 114 2493600 · info@lechler.com
India: Lechler (India) Pvt. Ltd. · Plot B-2 · Main Road · Wagle Industrial Estate · Thane (W) · 400604 · Phone: +91 22 40634444 · Fax: +91 22 40634497 · lechler@lechlerindia.com
Sweden: Lechler AB · Kungsängsvägen 31 B · 753 23 Uppsala · Phone: +46 54 137030 · Fax: +46 54 137031 · info@lechler.se
Spain: Lechler S.A. · Avda. Pirineos 7 · Oficina B7, Edificio Inbisa I · 28700 San Sebastián de los Reyes, Madrid · Phone: +34 91 6586346 · Fax: +34 91 6586347 · info@lechler.es
USA: Lechler Inc. · 445 Kautz Road · St. Charles, IL 60174 · Phone: +1 630 3776611 · Fax: +1 630 3776657 · info@lechlerUSA.com